

SMART HOMES NEED
INTELLIGENT SYSTEMS.

Air Excellent



ubbink

Build smart.



A smart system is an effective system.

Radial ductwork systems differ from traditional trunk and branch ductwork systems by running ducts between a distribution box and each habitable and wet room. The distribution box is then connected to a ventilation unit using mass flow ductwork and a silencer.

Smart because:

- The system pressure drop is lower as a result.
- Continuous duct runs with mechanical connections at either end also mean less air leakage.
- The ventilation rates can be controlled by flow restrictors in the distribution box.
- Cross-talk between rooms is reduced to an absolute minimum using mass flow ductwork and a silencer.



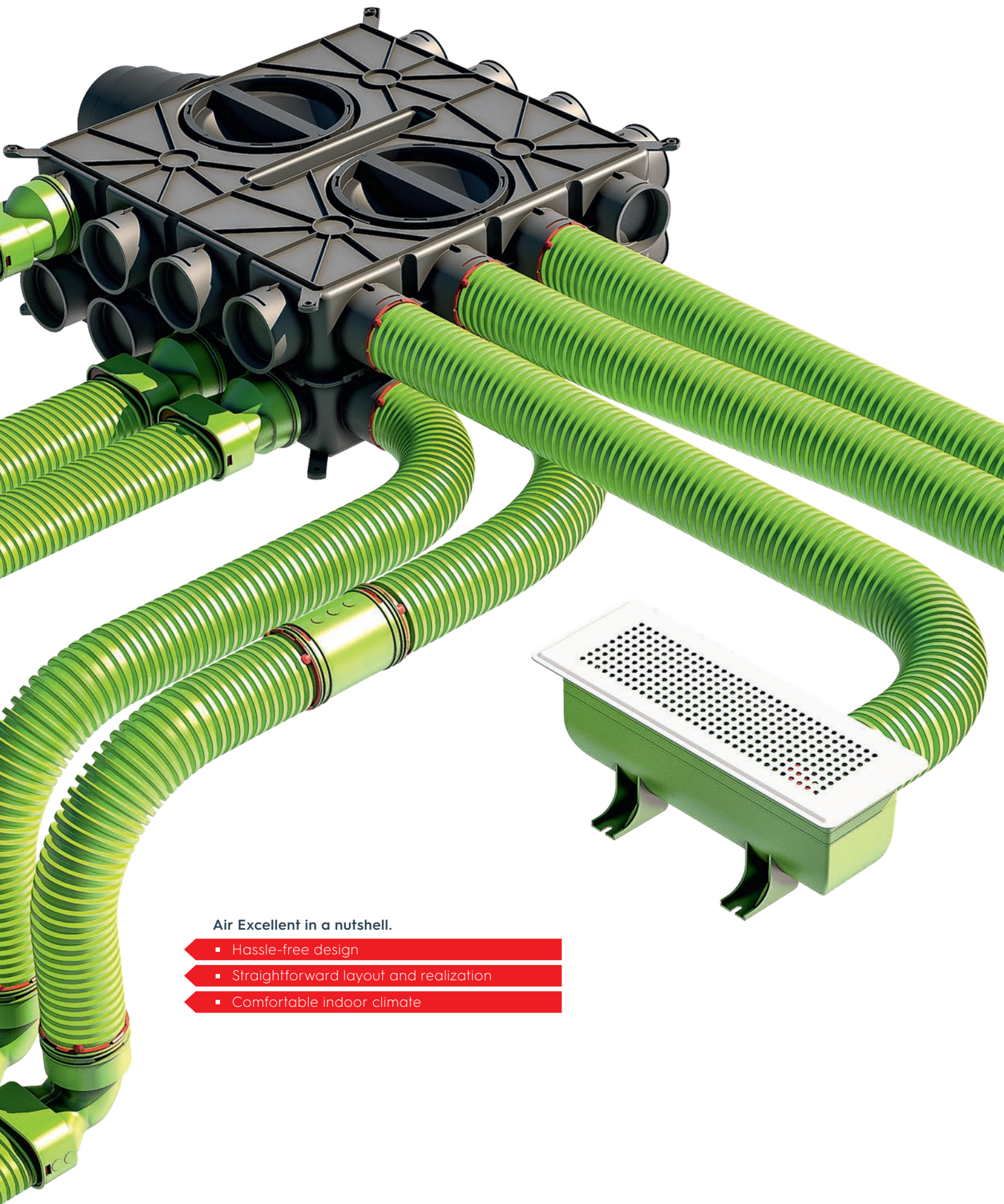

Air Excellent in a nutshell.

- Hassle-free design
- Straightforward layout and realization
- Comfortable indoor climate

Healthy air in every room by smart distribution.

As buildings become better insulated and airtight, purposed-provided ventilation is required to create and sustain a healthy and comfortable indoor air quality. The effectiveness of central mechanical ventilation systems with heat recovery is largely dependent upon the system used to distribute the air and the ductwork are the blood vessels in modern, energy-efficient

buildings. However, A poorly designed or installed air distribution system will waste energy through unnecessary pressure loss and/or air leakage because the ventilation unit will have to work harder to ventilate at the required rates, which may also cause unnecessary noise hindrance.



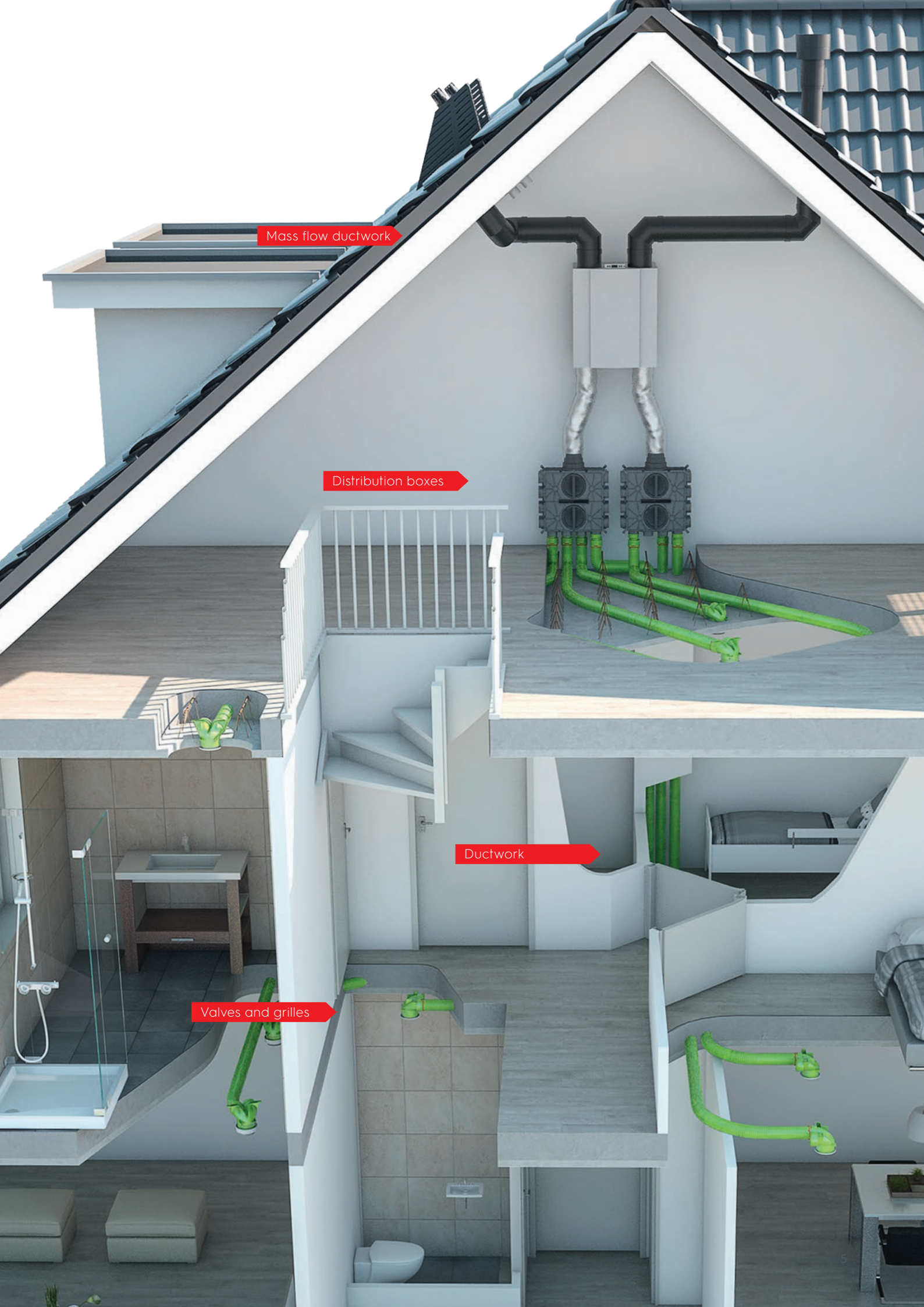

Mass flow ductwork

Distribution boxes

Ductwork

Valves and grilles

Speed up design, installation and commissioning.

- BIM-ready

- Continuously updated and optimized



© Image by Autodesk

Design

All Air Excellent parts are available as Autodesk AutoCAD and Autodesk Revit files enabling a fully automated and BIM-ready project planning. This not only helps create an accurate bill of material, but more importantly tackles potential problems off-site, i.e. before installation.

Easy to design



Simulate real-time installation



Easy control for the perfect air in every room.

The Air Excellent system comes with an online commissioning tool, which provides detailed information about the system pressure, a bill of material and last but not least the flow restrictor settings per duct run. The flow restrictors are an essential part of the Air Excellent system

since it is the tool to adjust the right air flow to the right room of the building. The Air Excellent commissioning tool calculates how to alter the restrictor. The calculation can be amended on-site if the installed-system differs from its original design.

Easy commissioning with an intuitive tool

- Detailed information about system pressure
- Flow restrictor



Your Air Excellent calculation

To save your calculation you need to create an account.



Air Supply	Volume	Rings removed	Velocity	Pressure loss	Pressure loss after adding restriction rings	Volume with restrictions
	m ³ /h	Setting	m/s	Pa	Pa	m ³ /h
Living room	50.0		2.3	59	59	50.0
Bedroom children 1	30.0	0	1.5	12	53	31.6
Bedroom children 2	30.0	0	1.5	13	54	31.3
Bedroom parents	40.0	3	2.1	20	54	41.8
150 (total)						

Volume	Rings removed	Velocity	Pressure loss	Pressure loss after adding restriction rings	Volume with restrictions
m ³ /h	Setting	m/s	Pa	Pa	m ³ /h
75.0		1.9	78	78	75.0

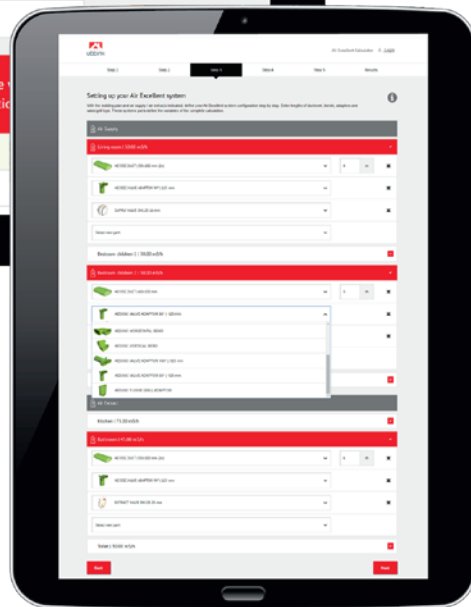

Building was never easier.

Ductwork on a roll is easy to lay out, cut to length and bend around obstacles. Mechanical connections, deliver quick, clean and consistent quality air-tight connections, which

makes Air Excellent ideal for pre-fabricated construction. The ductwork can be laid under screed floors, suspended under ceilings and hung in walls.



» FOR ALL NEW-BUILD
AND RENOVATION
APPLICATIONS «

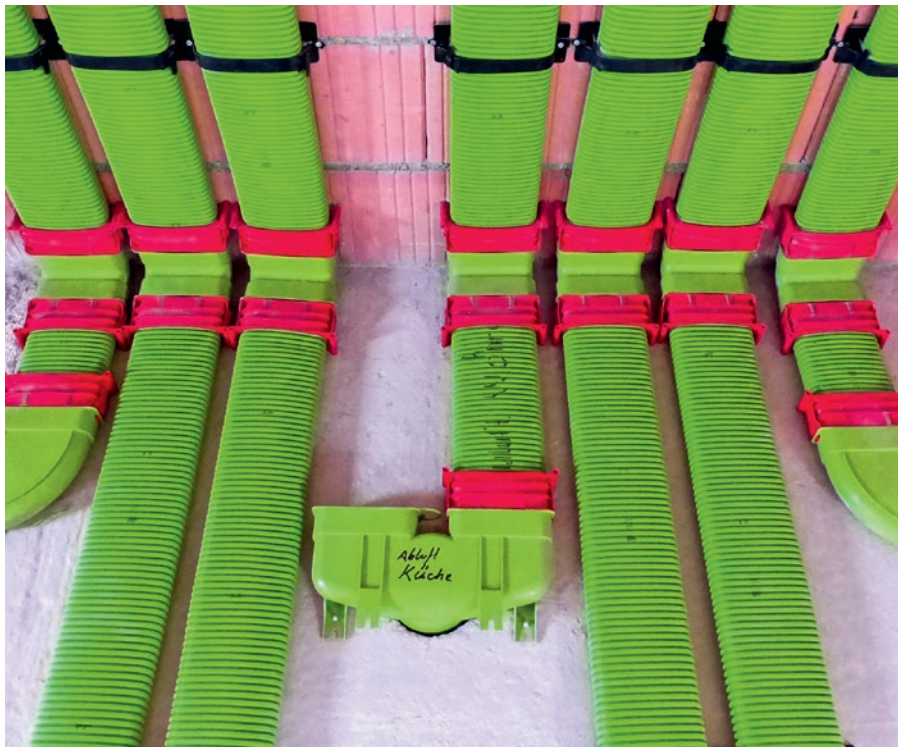



Flexible polyethylene outer layer

- For easy layout
- For effortless bending around obstacles

Ductwork details.

AE23C, DN63/52 mm				AE35SC, 50 x 102 mm			
							
1x AE23C		2x AE23C		1x AE35SC		2x AE35SC	
Volume [m³/h]	Velocity [m/s]	Volume [m³/h]	Velocity [m/s]	Volume [m³/h]	Velocity [m/s]	Volume [m³/h]	Velocity [m/s]
23,0	3,0	46,0	1,5	33,0	3,0	66,0	1,5
30,5	4,0	61,0	2,0	44,0	4,0	88,0	2,0

AE34C, DN75/63 mm				AE45SC, 50 x 140 mm			
							
1x AE34C		2x AE34C		1x AE45SC		2x AE45SC	
Volume [m³/h]	Velocity [m/s]	Volume [m³/h]	Velocity [m/s]	Volume [m³/h]	Velocity [m/s]	Volume [m³/h]	Velocity [m/s]
34,0	3,0	68,0	1,5	47,0	3,0	94,0	1,5
45,0	4,0	90,0	2,0	63,0	4,0	126,0	2,0

AE48C, DN90/75 mm				AE55SC, 60 x 132 mm			
							
1x AE48C		2x AE48C		1x AE55SC		2x AE55SC	
Volume [m³/h]	Velocity [m/s]	Volume [m³/h]	Velocity [m/s]	Volume [m³/h]	Velocity [m/s]	Volume [m³/h]	Velocity [m/s]
48,0	3,0	96,0	1,5	58,0	3,0	116,0	1,5
64,0	4,0	128,0	2,0	79,0	4,0	158,0	2,0

More details are available in separate datasheets.

Smart and complete.

There is a full set of accessories available to make any installation possible, including mixing circular and semi-circular ductwork. We know

that every market and every situation is different. And that's why we have been developing a system that will always work.

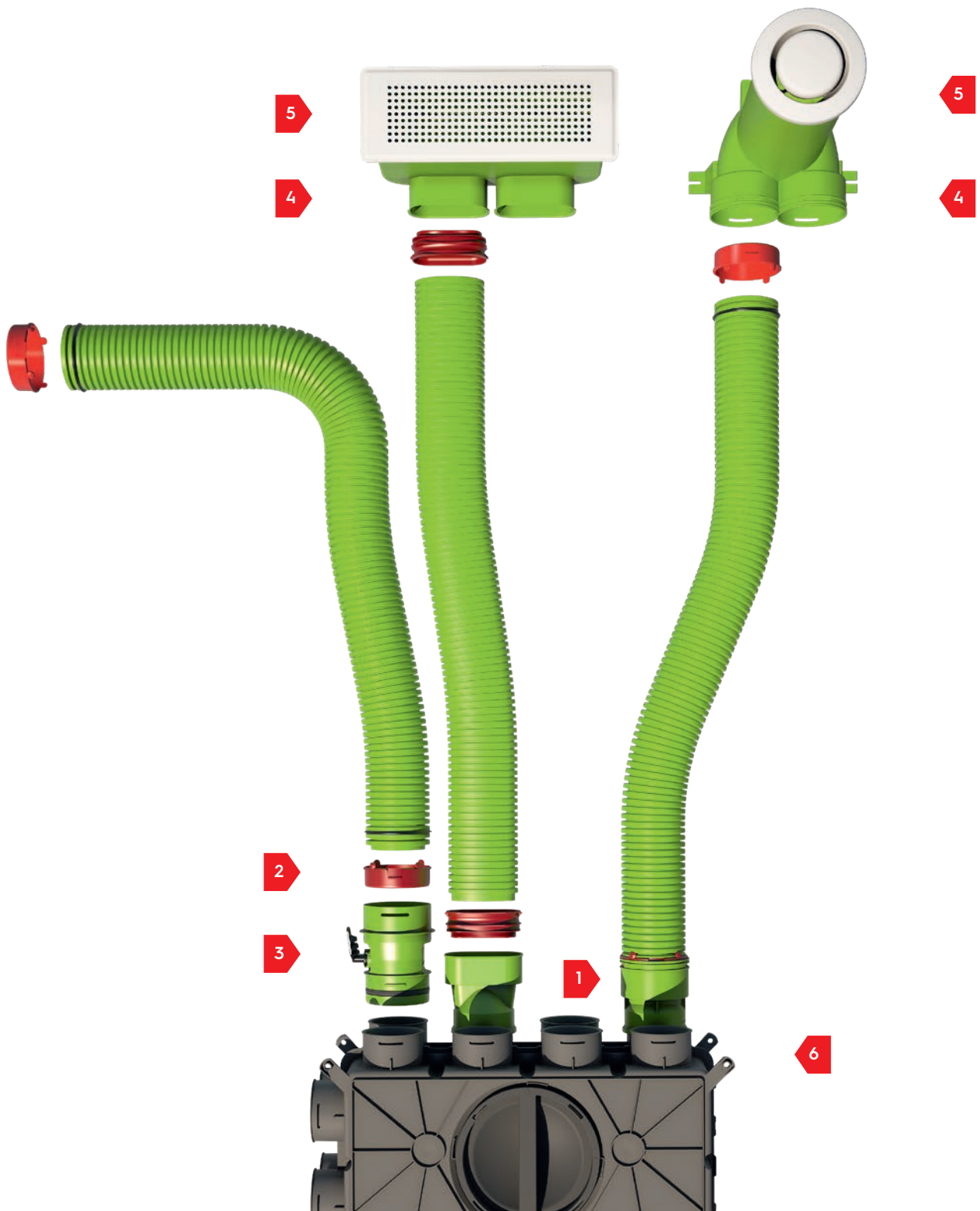

1 90° bends and adapters for mixing circular and semi-circular ductwork



2 Seals and click rings between ductwork components



3 Air flow restrictor

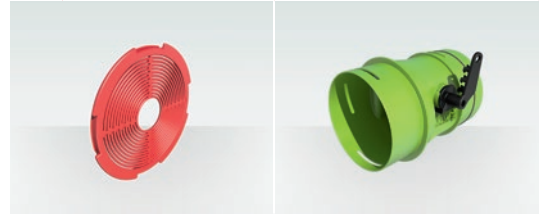

4 90° and 180° valve and grill adapters



5 Examples of valves and grilles



6 Various distribution boxes



Mass flow ductwork

Although not part of the Air Excellent portfolio, mass flow ductwork and silencers are essential parts of the ventilation system. Insulated mass flow ducts in air distribution systems used for ventilation, heating or cooling is often required to minimise heat loss or prevent condensation on or inside the duct. Silencers, which are placed between the ventilation unit and

the distribution boxes, minimize the transfer of sound produced by the ventilation unit. We have developed a complete range of insulated mass-flow ductwork, which is extremely easy to install. They are available in a large range of diameters. Several accessories including terminals and airtightness seals complete the program.

A complete range of parts



Features and benefits

- well insulated duct
- low pressure loss due to the very smooth inner surface
- light, easy to cut and pliable, impact resistant (i. e. no dents)
- doesn't rust
- comes in duct lengths of 2.00 m and in diameters 125, 150, 160 and 180 mm
- mechanical connections (i. e. no tape required)
- easy to dismantle, which makes maintenance very easy

Distribution boxes

The distribution box is an important part of radial ventilation systems, like Air Excellent. It connects between the ventilation unit and the valves that are installed in the habitable and wet rooms. Within the distribution boxes, the air capacity to the duct runs can be adjusted by air flow restrictors that are mounted in the

ductwork connections of the distribution box. The type of distribution box required, depends on the total volume required, the number of duct runs and the desired system performance. The Air Excellent online configurator is a great help for determining a complete system.

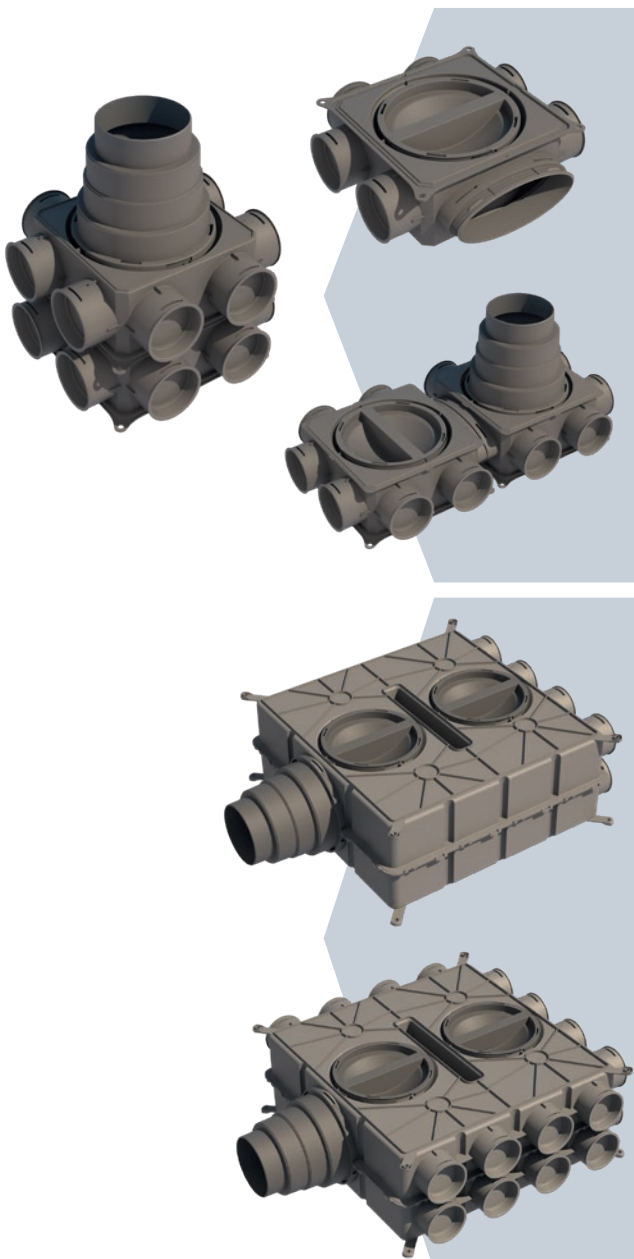

The 200 Series distribution boxes.

The 200 Series distribution boxes are a modular system that can be characterized by functional partitioning into scalable and reusable modules, interfacing with a constant changing building environment. The system consists of basic box configurations, extension kits and adapters that can be merged to function as one system.

This allows tailor-made solutions for any installation and prevents oversized installations. Its small dimensions make it ideal for residential buildings that require lower air volumes or buildings that have limited installation space. Installations do not require separate mounting brackets and can be executed by a single person on walls, floors and ceilings.

The 800 Series universal distribution boxes.

The 800 Series distribution boxes are a universal “one for all” solution for many installations and come in three fixed configurations. The DB808 has 8 ductwork connections, the DB816 has 16 connections and the DB824 delivers the logical 24 connections for maximum installation freedom.

Mass flow ductwork is connected by the use of a stepped mass flow adaptor that connects the diameters of 125, 150, 160 and 180 mm. Connections can be done vertically or horizontally. Additionally, the 800 Series distribution boxes can be upgraded with a sound damping kit to further enhance system performance by absorbing system noise caused by for instance the ventilation unit or cross talk.

Its larger dimensions make it ideal for residential buildings that require higher air volumes. Installations do not require separate mounting brackets and can be executed by a single person on walls, floors and ceilings.

The 200 Series distribution boxes.

The 200 Series distribution boxes are a modular system that can be characterized by functional partitioning into scalable and reusable modules, interfacing with a constant changing

building environment. The system consists of basic box configurations, extension kits and adapters that can be merged to function as one system.

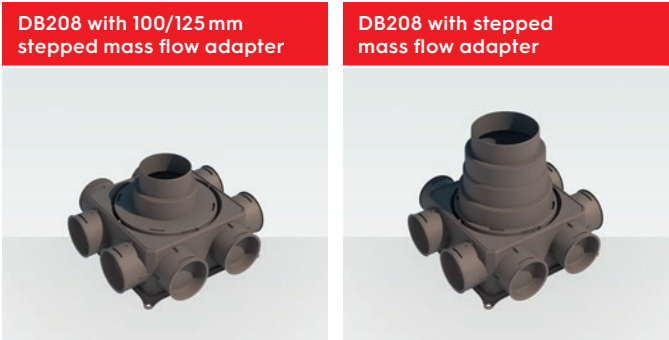

The DB208 distribution box.

The DB208 distribution box comes standard with 8 ductwork connections for the basic box with two ductwork connection on each side. Mass flow ductwork can be connected vertically with stepped adapters for 100/125 mm.



The DB206 distribution box.

The DB206 distribution box comes standard with 6 ductwork connections for the basic box and an oval side connection that can be used for inspection, cleaning, changing flow restrictors or connecting mass flow ductwork.

Mass flow ductwork can also be connected vertically offering several installation possibilities.

Horizontal and vertical extensions.

A keen feature of the 200 Series is the possibility of connecting multiple boxes.

Both the DB206 and DB208 can be vertically extended becoming a stacked-configuration with 12 ductwork connections for the DB206 and 16 connections for the DB208.

The oval side connection from the DB206 allows connecting to another DB206 as well, again offering a 12-connection horizontally extended configuration. This makes the 200 Series a very scalable solution.

DB206, horizontally extended



DB208, vertically extended



DB206, vertically extended



The 800 Series universal distribution boxes.

The 800 Series distribution boxes are a universal “one for all” solution for many installations and come in three fixed configurations. The DB808 has 8 ductwork connections, the DB816 has 16 connections and the DB824 delivers the logical 24 connections for maximum installation freedom.





Mass flow ductwork is connected by the use of a stepped mass flow adaptor that connects the diameters of 125, 150, 160 and 180 mm. Connections can be done vertically or horizontally. Additionally, the 800 Series distribution boxes can be upgraded with a sound damping kit to further enhance system performance by absorbing system noise caused by for instance the ventilation unit or cross talk.



Its larger dimensions make it ideal for residential buildings that require higher air volumes. Installations do not require separate mounting brackets and can be executed by a single person on walls, floors and ceilings.

It's smart.

Air Excellent has been awarded with, the industry-first, TÜV SÜD quality mark TAK-01-2013 for non-metallic ductwork systems and is the only system in the market that provides a complete portfolio in pipes and fittings for a complete ventilation system.

Materials:

The Air Excellent ductwork is made of Polyethylene (PE), which gives the ductwork its characteristic semi-rigid behavior. The accessories such as the valve adapters, the bends and the connectors are manufactured of PP to give it stronger rigid properties. The 2K molded seals

belonging to the semi-circular ductwork types include TPE material to warrant flexibility and airtightness. The ductwork can be supplied with anti-static and anti-bacterial properties. All Air Excellent parts are manufactured using virgin raw materials.



Warranting excellence:

Exceptional efforts are taken to reach a high quality level for production, premium product features and a high performance level. The duct has a very smooth inner-layer to keep pressure drop to a minimum offering a high-efficient air

distribution system. Furthermore, we work closely with several renowned laboratories and notified bodies to have our products independently tested, qualified and certified.

It's proofed.

The following is included in the TÜV SÜD quality mark TAK-01-2013 for non-metallic ductwork systems:

Typical working pressure ¹	-500 Pa up +500 Pa
Ring stiffness	Tested according to ISO9969
Airtightness class	AE23C, AE34C, AE48C, AE35SC and AE55SC: Airtightness Class D for Air Excellent ductwork, Air Excellent ductwork accessories and the Air Excellent plastic distribution boxes. Tested at system pressure: +2000 Pa/-2000 Pa AE45SC: Airtightness Class C for Air Excellent ductwork, Air Excellent ductwork accessories and the Air Excellent plastic distribution boxes. Tested at system pressure: +2000 Pa/-2000 Pa
Operating temperature range	-20 °C up to +60 °C
Reaction to fire ²	Class E (according to European standard EN 13501-1)
External pressure resistance	All ductwork can be applied into concrete work, holding a maximum concrete height of 200 mm above the ductwork.
Bending radii ³	AE23C, AE34C and AE48C: Radius: 150 mm AE35SC and AE45SC: Radius: 150 mm (vertical) and 200 mm (horizontal) AE55SC: Radius: 200 mm (vertical) and 400 mm (horizontal)
Mechanical connector strength	Individual mechanical connections can hold 10 m duct run (during installation)
Flexibility check ⁴	Bendable without tools and without duct damaging
Duct stiffness	One mounting bracket per 2 m duct run avoid bending is recommended (ceiling installations)
Microbial resistance ⁵	99,9 % of bacteria died during tests with typical bacteria
Food compatiblenss ⁵	No harmful substances are released to the air
Anti-static function	Surface resistance is < 10 ¹² Ohm
Cleaning treatment	No damages after cleaning according to prescribed methods

- 1 Air Excellent can operate under a higher range depending on the installation
- 2 Tested by EFACTIS in The Netherlands
- 3 Technical datasheets with more details available upon request
- 4 For installation under cold circumstances, we advise to warm up the ductwork with warm air
- 5 Tested by ISEGA





ENERGY



VENTILATION



BUILDING



Ubbink International

@ info@ubbink.com •  www.ubbink.com

© 2021 - Ubbink Centrotherm Group | Content is subject to change without notice; no liability for errors and misprints. | Availability and configurations may differ per country. | UB-2021-01-V01-INT-EN